

SPECIFICATION

CTEZED 25 HV

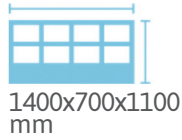

WORKING ENVELOPE

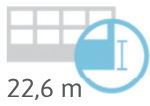
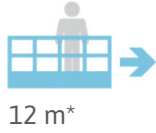
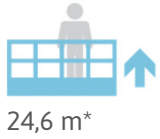
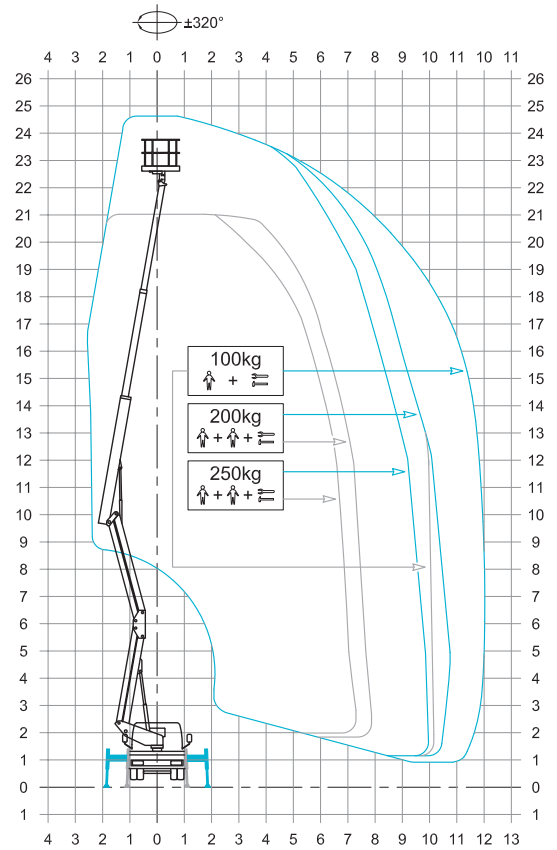

* outreach and height max values and repeatability can change within $\pm 3\%$ due to manufacturing variation and working condition.

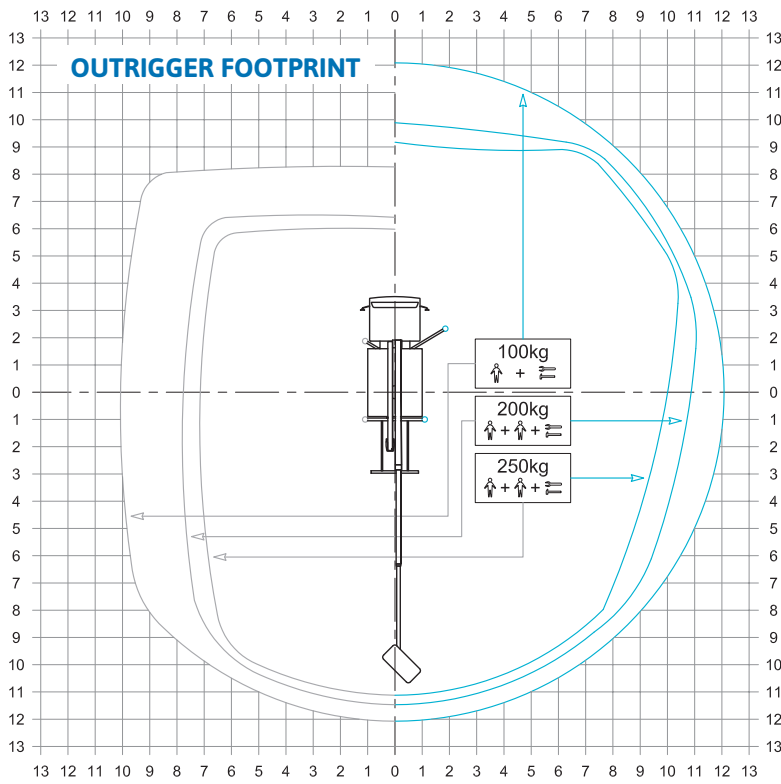

DIMENSIONS

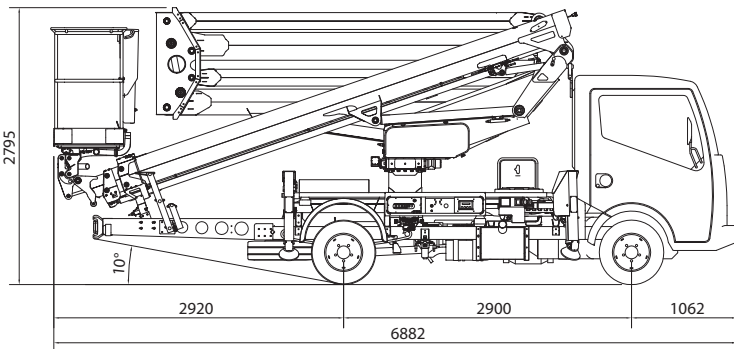
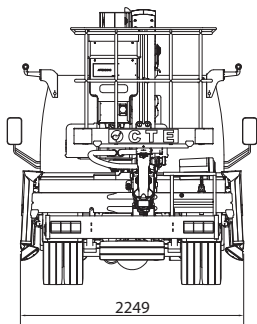

CTE S.p.A.
 Headquarter 7 Via Caproni - Rovereto (TN) IT, 38068
 Ph. +39 0464 48.50.50 - Fax +39 0464 48.50.99
 info@ctelift.com - www.ctelift.com
 Factory 5 Loc. Terramatta - Rivoli Veronese (VR) IT, 37010
 CTE UK Ltd Enderby Leicestershire - UK

Product specifications are subject to change without notice or obligation. Technical features and drawings in this brochure are for illustrative purposes only. _ZED 25 HV - ed. 10/18

